

<sup>®</sup>  
**Pentruder**

## ACCESSORY GUIDE

Official Pentruder Distributor:



**Diamantværktøj**

# OVERVIEW PENTRUDEER CONCRETE CUTTING SYSTEM

## HF-power packs

### Pentpak 427, 3-phase

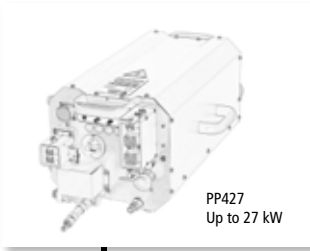

## Remote control and cables

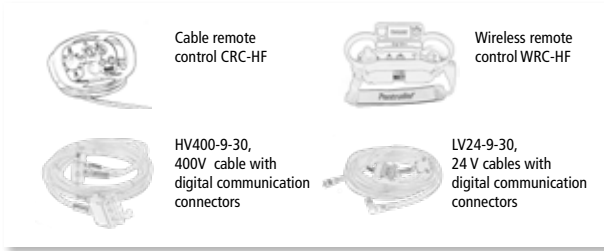

## Electrical motors

### 27 kW HF    22 kW HF    18 kW HF    15 kW HF



## Wall saws

### Pentruder 8-20iQ

### Pentruder 8-20HF

### Pentruder CBK

### Pentruder 6-12HF

## Wire saw modules

## Drilling modules

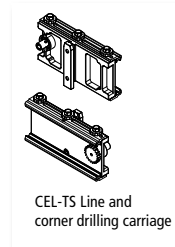
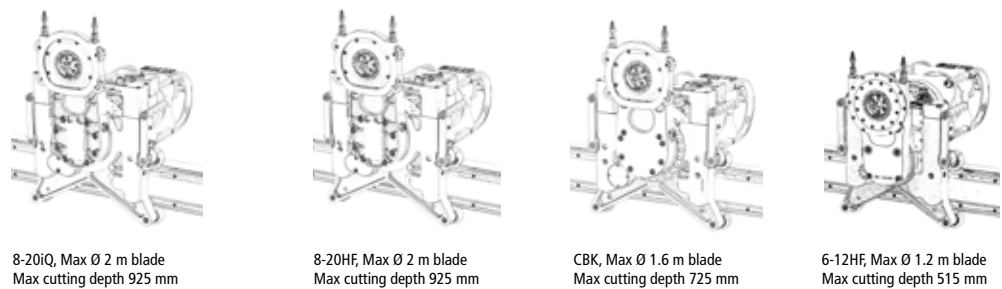

## Track system for

## wall sawing

## wire sawing

## drilling

### TS Track

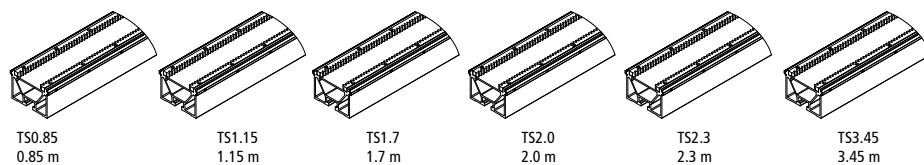

### Track foot TF2S

### Track foot angular TFAB

### Base plate BTS-4

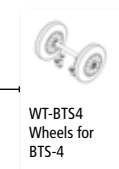
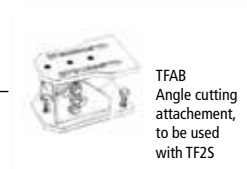

# TS TRACK SYSTEM

15 18 kW HF  
**Pentrunder 6-10HF**

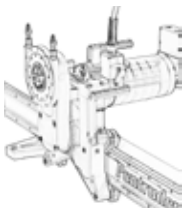

6-10HF, Max Ø 1.2 m blade  
 Max cutting depth 515 mm

18 22 27 kW HF  
**Pentrunder 3P8**

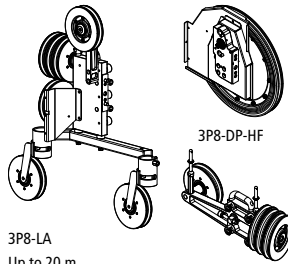

3P8-LA  
 Up to 20 m  
 storage capacity

3P8-DP-HF

3P8-UA

15 18 22 kW HF  
**Pentrunder MD1**

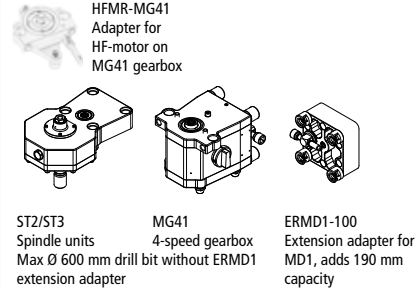

HFMR-MG41  
 Adapter for  
 HF-motor on  
 MG41 gearbox

ST2/ST3  
 Spindle units  
 Max Ø 600 mm drill bit without ERMD1  
 extension adapter

MG41  
 4-speed gearbox

ERMD1-100  
 Extension adapter for  
 MD1, adds 190 mm  
 capacity

**Universal**

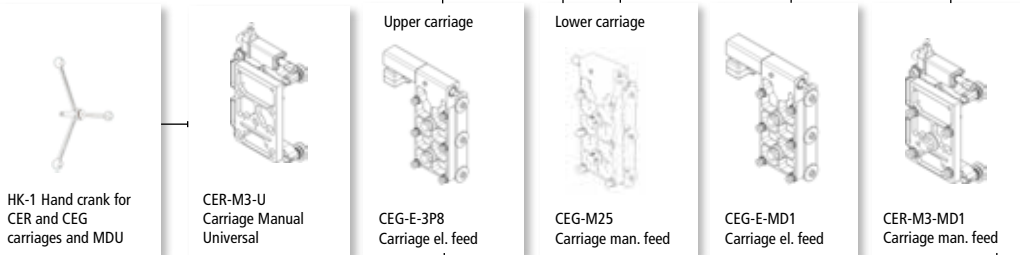

HK-1 Hand crank for  
 CER and CEG  
 carriages and MDU

CER-M3-U  
 Carriage Manual  
 Universal

Upper carriage

CEG-E-3P8  
 Carriage el. feed

Lower carriage

CEG-M25  
 Carriage man. feed

CEG-E-MD1  
 Carriage el. feed

CER-M3-MD1  
 Carriage man. feed

Back support for  
 TS track



RST-TS1

**Base plate BTS-5**



BTS-5  
 For TS Track



WT-BTS5-300  
 Wheels for BTS-5

# OVERVIEW PENTRUDEER CONCRETE CUTTING SYSTEM

## HF-power pack

### Pentpak 427, 3-phase

### Remote control and cables

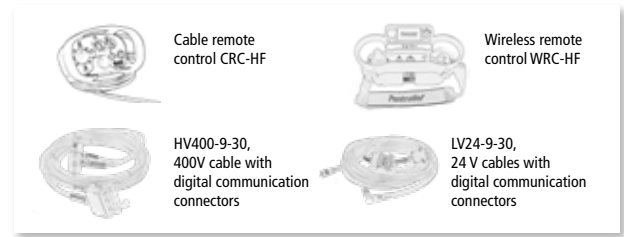

## Electrical motors

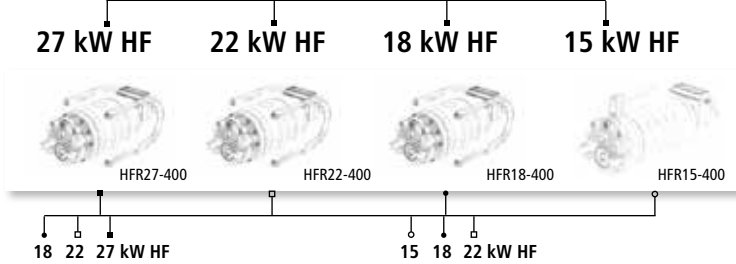

## Wire saw modules

## Drilling modules

### Pentruder 3P8

### Pentruder MD1

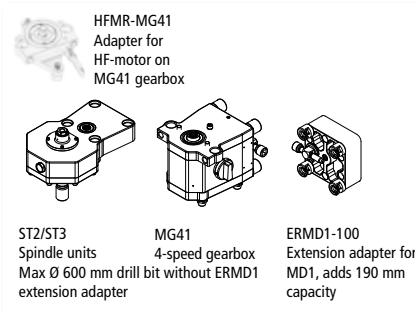
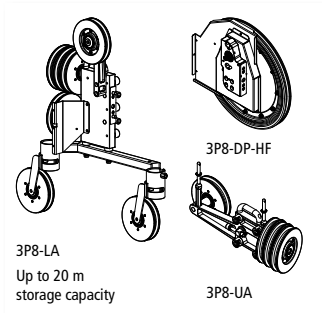

## Rig system with 70 mm column for

## wire sawing

## drilling

### Carriages

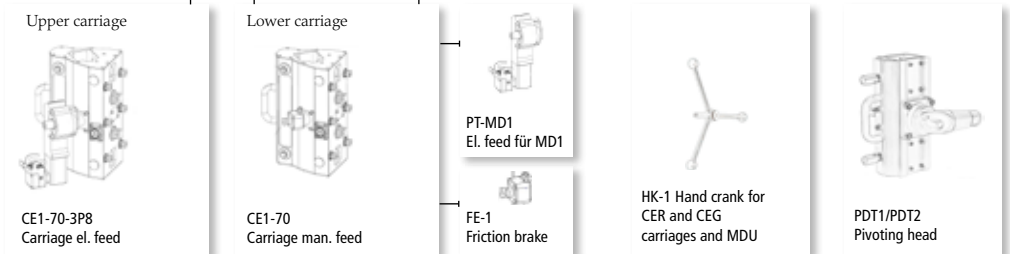

### Columns

### Rear support

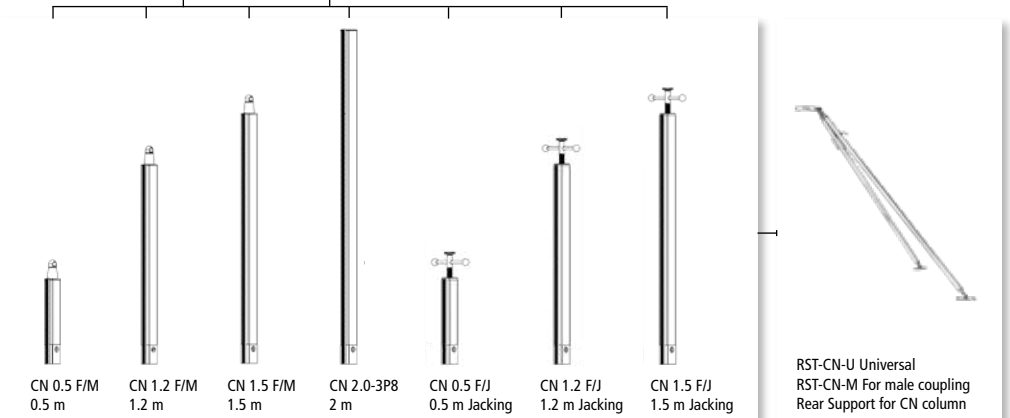

### Base plate

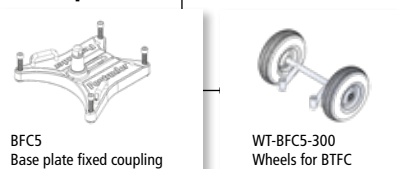

# 70 MM COLUMN SYSTEM

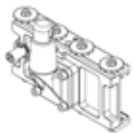

CEL-CN Line and corner drilling carriage for TS track and CN column



CT-CEL Back support for CEL-CN and CEL-TS

## TS Track



TS 0.85, TS1.15, TS1.7, TS2.0, TS2.3, TS3.45  
TS Track 0.85, 1.15, 1.7, 2.0, 2.3, 3.45 m lengths



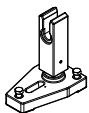





## Track foot



TF25  
Swivelling fork

**PART NUMBER    MCCS CODE    DESCRIPTION**

B-2000    B-20HF    CBK    B-12HF    B-10HF    3P8 on column    3P8 on track    M01 on column    M01 on track    Universal drill rig

HIGH FREQUENCY POWER PACKS										
09274001DIG	PP427	Pentpak 427, HF Power Pack, up to 27 kW, 380 – 480V, 50-60 HZ	X	X	X	X	X	X	X	X
 <p>PP427</p>										
CABLES										
64900201	HV400-9-30	Cable 400V, 9m	X	X	X	X	X	X	X	X
64900101	LV24-9-30	Cable 24V, 9m with water hose	X	X	X	X	X	X	X	X
 <p>LV24-9-30</p>  <p>HV400-9-30</p>										
REMOTE CONTROL UNITS										
64190401	CRC-HF	Cable remote control, HF	X	X	X	X	X	X	X	X
WRC-HF	WRC-HF	Wireless remote control, HF	X	X	X	X	X	X	X	X
 <p>CRC-HF</p>  <p>WRC-HF</p>										
HIGH FREQUENCY MOTORS										
07154001DIG	HFR415	HF Motor, 15 kW, 400V	X	X	X	X	X		X	X
07184001DIG	HFR418	HF Motor, 18 kW, 400V	X	X	X	X	X	X	X	X
07224001DIG	HFR422	HF Motor, 22 kW, 400V	X	X	X			X	X	X
07274001DIG	HFR427	HF Motor, 27 kW, 400V	X		X			X	X	
 <p>HFR415</p>  <p>HFR427 HFR422 HFR418</p>										
PROTECTIVE CAPS										
CAPS-HF	CAPS-HF	Kit for HF wall saw, HF motor and HF Pentpak	X	X	X	X	X	X	X	X
<i>Recommended caps if a cable remote is used (not included in CAPS-kit):</i>										
64115300		Protective cap remote control connector on HF Pentpak	X	X	X	X	X	X	X	X
64115700		Protective cap remote control connector on cable	X	X	X	X	X	X	X	X
 <p>Kit for HF wall saws, HF-motor and HF Pentpak</p>										

**PART NUMBER    MCCS CODE    DESCRIPTION**

8-20IQ    8-20HF    CBK    6-12HF    6-10HF    3PB on column    3PB on track    MDI on column    MDI on track    Universal drill rig

**HF-SAW HEADS**

10050601DIG	8-20IQ	Pentruder 8-20iQ, HF saw head	X																
10050101DIG	8-20HF	Pentruder 8-20HF, HF saw head		X															
10090101DIG	CBK	Pentruder CBK, HF saw head			X														
10060101DIG	6-12HF	Pentruder 6-12HF, HF saw head				X													
10060201DIG	6-10HF	Pentruder 6-10HF, HF saw head					X												



Pentrunder 8-20iQ / 8-20HF



Pentrunder CBK



Pentrunder 6-12HF



Pentrunder 6-10HF

**BLADE FLANGES STANDARD**

42880101	QE60	Inner and outer blade flange, 60 mm arbor size, incl. center bolt	X	X	X	X	X												
42880401	QE60-3	Inner and outer flange, 60 mm arbor size including 3x centre bolts. Use for Ø 1600 – 2000 mm blades	X	X	X														



QE Blade flange assembly  
QE60 - Ø 60 mm arbor

**BLADE FLANGES, FLUSH CUTTING**

42040101	QEF60-130	Flush cutting flange, 6x M8, BC 130 mm	X	X	X	X	X												
42040201	QEF60-110	Flush cutting flange, 6x M10, BC 110 mm	X	X	X	X	X												
42040501	QEF60-110-130	Flush cutting flange, 6x M10, BC 110 mm / 6x M8, BC130 mm	X	X	X	X	X												



QEF60-130 - flush



QEF60-110 - flush



QEF60-110-130 - flush

**GROOVE CUTTING**

DBF05	DBF05	Double blade flange 5 mm spacer, BC 110/130 cpl	X	X	X	X	X												
DBF10	DBF10	Double blade flange 10 mm spacer, BC 110/130 cpl	X	X	X	X	X												
DBF15	DBF15	Double blade flange 15 mm spacer, BC 110/130 cpl	X	X	X	X	X												
DBF20	DBF20	Double blade flange 20 mm spacer, BC 110/130 cpl	X	X	X	X	X												
DBF25	DBF25	Double blade flange 25 mm spacer, BC 110/130 cpl	X	X	X	X	X												
DBF30	DBF30	Double blade flange 30 mm spacer, BC 110/130 cpl	X	X	X	X	X												
11054001	GPE-800-DBF40	Blade guard full for DBF Double blade flange, parallel, eccentric lock, Ø 800 MM / 32"	X	X	X	X	X												



DBF Double blade flange



Blade guard full for DBF

**BLADE GUARD HOLDERS**

43210601	GH-SW1	Frame blade guard holder for all swing type blade guards	X	X	X	X	X											
GH-P8-20	GH-P8-20	Parallel guide for parallel blade guards and 8-20HY, 6-16HY, 8-20HF	X	X														
GH-PCBK	GH-PCBK	Parallel guide for parallel blade guards and CBK			X													
GH-P6-12	GH-P6-12	Parallel guide for parallel blade guards and 6-12HF, 6-12HY				X	X											



GH-SW1 Blade guard frame for standard guards



Parallel guide

**BLADE GUARD FULL, SWING TYPE**

11080701	GS-800	Blade Guard full, Swing type, Ø 800 mm/32"	X	X	X	X	X											
11080801	GS-1000	Blade Guard full, Swing type, Ø 1000 mm/40"	X	X	X	X	X											
11081601	GS-1100	Blade Guard full, Swing type, Ø 1100 mm/42"	X	X	X	X	X											
11080901	GS-1200	Blade Guard full, Swing type, Ø 1200 mm/48"	X	X	X	X	X											
11081001	GS-1600	Blade Guard full, Swing type, Ø 1400 mm/54"	X	X	X													
11081701	GS-1400	Blade Guard full, Swing type, Ø 1600 mm/63"	X	X	X													



GS Blade guard

**BLADE GUARD FULL, SWING TYPE, ECCENTRIC LOCK**

11082001	GSE-600	Blade Guard full, Swing type, Eccentric lock, Ø 600 mm/26"	X	X	X	X	X											
11082101	GSE-800	Blade Guard full, Swing type, Eccentric lock, Ø 800 mm/32"	X	X	X	X	X											
11082201	GSE-1000	Blade Guard full, Swing type, Eccentric lock, Ø 1000 mm/40"	X	X	X	X	X											
11082301	GSE-1200	Blade Guard full, Swing type, Eccentric lock, Ø 1200 mm/48"	X	X	X	X												
11082401	GSE-1600	Blade Guard full, Swing type, Eccentric lock, Ø 1600 mm/63"	X	X	X													
11081101	GSE-2000	Blade Guard full, Swing type, Eccentric lock, Ø 2000 mm/79"	X	X														



GSE Blade guard

**BLADE GUARD, SWING TYPE, FLUSH**

11090601	GSF-800	Blade guard, Swing type, Flush, Ø 800 mm / 32"	X	X	X	X	X											
11090701	GSF-1000	Blade guard, Swing type, Flush, Ø 1000 mm / 40"	X	X	X	X	X											
11091001	GSF-1100	Blade guard, Swing type, Flush, Ø 1100 mm / 42"	X	X	X	X	X											
11090801	GSF-1200	Blade guard, Swing type, Flush, Ø 1200 mm / 48"	X	X	X	X	X											
11091101	GSF-1400	Blade guard, Swing type, Flush, Ø 1400 mm / 54"	X	X	X													
11090901	GSF-1600	Blade guard, Swing type, Flush, Ø 1600 mm / 63"	X	X	X													



GSF Blade guard



**BLADE GUARD FULL, PARALLEL, ECCENTRIC LOCK**

11052001	GPE-600	Blade guard full, Parallel, Eccentric lock, Ø 600 mm / 26"	X	X	X	X	X								
11052101	GPE-800	Blade guard full, Parallel, Eccentric lock, Ø 800 mm / 32"	X	X	X	X	X								
11052201	GPE-1000	Blade guard full, Parallel, Eccentric lock, Ø 1000 mm / 40"	X	X	X	X	X								
11052301	GPE-1200	Blade guard full, Parallel, Eccentric lock, Ø 1200 mm / 48"	X	X	X	X	X								



GPE Blade guard

**BLADE GUARD FULL, PARALLEL**

11050501	GP-600	Blade guard full, Parallel, Ø 600 mm / 26"	X	X	X	X	X								
11050601	GP-800	Blade guard full, Parallel, Ø 800 mm / 32"	X	X	X	X	X								
11050701	GP-1000	Blade guard full, Parallel, Ø 1000 mm / 40"	X	X	X	X	X								



GP Blade guard

**TRANSPORT TROLLEY**

07810101	TYHF	Transport trolley for HF saws cpl.	X	X	X	X	X								
----------	------	------------------------------------	---	---	---	---	---	--	--	--	--	--	--	--	--



Transport trolley for HF wall saws

**WIRE SAW MODULES, 3P8**

10910201	3P8-LA	3P8 Lower assembly							X	X					
10910101	3P8-UA	3P8 Upper assembly							X	X					
10900101	3P8-DP-HF	3P8 Drive pulley, Electric							X	X					
57253101		Slip clutch unit 3P8 cpl - Fitted between drive pulley and HF motor. Use to absorb shock loads from jamming of wire							X	X					



3P8-UA Upper assembly



3P8-LA Lower assembly



3P8-DP-HF Drive pulley, electric



Slip clutch for HF-motor

**WIRE SAW GUARDS, 3P8**

11200301	3P8-LMG	3P8 Telescoping magazine guard							X	X					
11200501	3P8-SSG	3P8 Slack side telescoping guard							X	X					
11200401	3P8-TG	3P8 Top guard							X	X					
11200201	3P8-DPG	3P8 Drive pulley guard							X	X					



3P8-LMG Guard, storage pulleys



3P8-SSG Guard, slack side telescoping guard



3P8-TG Guard, upper assembly



3P8-DPG Guard, drive pulley

**PART NUMBER      MCCS CODE      DESCRIPTION**

B-2010    B-20HF    CBK    B-12HF    B-10HF    3P8 on column    3P8 on track    MD1 on column    MD1 on track    Universal drill rig

WIRE SAW ACCESSORIES, 3P8										
07710101	WSP2-90	Satellite pulleys, universal, 2-link, 90°							X	X
07710201	WSP2-180	Satellite pulleys, universal, 2-link, 180°							X	X
07720101	WSP1-F	Satellite pulley, single, flush cpl							X	X
378107202108		Drive belt for 3P8							X	X
45068801		Pulley 3P8 Ø 200 complete							X	X



WSP2-90 Satellite pulleys, universal, 2-link, 90°



WSP2-80 Satellite pulleys, universal, 2-link, 180°



WSP1-F Satellite pulley, single, flush

MODULES MD1 DRILL SYSTEM												
10801001	MG41	MG41 Heavy Duty 4-speed Gearbox for HF motors and hydraulic motors								X	X	
HFMR-MG41	HFMR-MG41	Adapter with slip clutch, for HF motors on MG41 gearbox								X	X	
64920101		Connector with ID-chip for MD1 70mm (manual feed only)								X		
64909101		Connector with ID-chip for man. CER/CEG (manual feed only)									X	
10701001	ST2-1-1/4	Heavy Duty Spindle Unit ST2 for MG41 for up to Ø 1000 or bigger mm drill bits Spindle thread 1-1/4" - 7 UNC								X	X	
10703001	ST3-1-1/4	Heavy Duty Spindle Unit ST3 for MG41 for up to Ø 650 mm drill bits. Spindle thread 1-1/4" - 7 UNC								X	X	
10711001	ST2-QDC	Heavy Duty Spindle Unit ST2 for MG41 for up to Ø 1000 mm or bigger drill bits. Spindle with quick disconnect coupling.								X	X	
10711101	ST3-QDC	Heavy Duty Spindle Unit ST3 for MG41 for up to Ø 650 mm drill bits. Spindle with quick disconnect coupling.								X	X	
56070101	ERMD1	Heavy Duty Extension Adapter for MD1 type quick disconnect coupling. Extends capacity by Ø 190 mm per adapter. Can be stacked.								X	X	X
34420100	QDC - 1-1/4	Spindle adapter QDC - 1-1/4"-7 UNC								X	X	
34421100	QDC-84	Spindle adapter QDC - 84 mm P.C. D								X	X	
34420200	QDC-94	Spindle adapter QDC - 94 mm P.C.D								X	X	



MG41 HF



Connector with ID-chip



HFMR-MG41 Adapter



ST2 / ST3 Spindle unit



ERMD1 Extension adapter



QDC drill bit adapters  
QDC-1-1/4" \*\*  
QDC-84, 3 holes, PCD84  
QDC-94, 6 holes, PCD94

**HYDRAULIC MOTORS AND FEED UNITS, MD1 DRILL SYSTEM**

HR16R-MD1	HR16R-MD1	Hydraulic motor, reversible, 16 cc. For MG41 gearbox with PP15/PP20. (42 Liter / min)										X	X
HR25R-MD1	HR25R-MD1	Hydraulic motor, reversible, 25 cc. For MG41 gearbox with PP15/PP20. (42 Liter / min)										X	X



HR16R-MD1  
HR25R-MD1

**CARRIAGES AND FEED UNITS FOR WIRE SAWING AND DRILLING, 70 MM COLUMN RIG**

10501001	CE1-70	Carriage CE1 for 70 mm columns. MD1 core drill carriage and 3P8 wire saw lower carriage. Use with PT electrical feed unit or FE1 friction brake.								X		X	
10501201	CE1-70-3P8	Carriage CE1 for 70 mm columns. 3P8 wire saw upper carriage								X		X	
57520301	FE1	Friction brake for CE1-70 carriage when used without electrical feed unit								X		X	
10550101	PT-3P8	Electric feed unit for 3P8 wire saw (91:1) (upper carriage)								X			
10550201	PT-MD1	Electric feed unit MD1 core drill (43:1) for CE1-70										X	
10541001	PT-HY32	Hydraulic feed unit for CE1-70								X	X	X	



CE1-70 Carriage, with  
FE1 Friction brake



CE1-70-3P8 Upper carriage,  
automatic feed

**70 MM COLUMNS WITH CONICAL COUPLING**

10210501	CN 0.5 F/M-70	Column CN 0.5 F/M - 70 steel cpl (with male and female coupling), incl. one ET70 eccentric bolt										X	X
10211201	CN 1.2 F/M-70	Column CN 1.2 F/M - 70 steel cpl (with male and female coupling), incl. one ET70 eccentric bolt										X	X
10211501	CN 1.5 F/M-70	Column CN 1.5 F/M - 70 steel cpl, incl. one ET70 eccentric bolt										X	X
10222000	CN 2.0-3P8	Column, Steel 2.0m for 3P8, incl. one ET70 eccentric bolt										X	X
10220501	CN 0.5 F/J-70	Column CN 0.5 F/J - 70 steel cpl, incl. one ET70 eccentric bolt										X	X
10221201	CN 1.2 F/J-70	Column CN 1.2 F/J - 70 steel cpl, incl. one ET70 eccentric bolt										X	X
10221501	CN 1.5 F/J-70	Column CN 1.5 F/J - 70 steel cpl, incl. one ET70 eccentric bolt										X	X



CN-F/M column, Female/Male conical coupling



CN-F/J column, Female/Jacking screw

BASE PLATE, WHEELS AND ACCESSORIES, COLUMNS WITH CONICAL COUPLING										
BFC5	BFC5	Base plate with fixed conical coupling, swivelling							X	X
WT-BFC5	WT-BFC5	Wheels for BFC5						X	X	
34080500	ET70	Eccentric bolt for TTFF and JTFF/JTFM tracks						X	X	
RST-CN-U	RST-CN-U	Rear support for 70 mm column universal						X	X	
RST-CN-M	RST-CN-M	Rear support for 70 mm column male coupling						X	X	
10601001	PD1	Pivoting Head PD1, fixed coupling, for 70 mm columns						X	X	
10601101	PD2	Pivoting head PD2 adjustable, for 70 mm columns						X	X	







TRACKS WITH T-SLOT, TRACK SYSTEM										
49031801	TS0.85	Track, T-slot type, 0.85 m / 33"	X	X	X	X	X		X	X
49031901	TS1.15	Track, T-slot type, 1.15 m / 45"	X	X	X	X	X		X	X
49032001	TS1.7	Track, T-slot type, 1.7 m / 67"	X	X	X	X	X		X	X
49032101	TS2.0	Track, T-slot type, 2.0 m / 79"	X	X	X	X	X		X	X
49032201	TS2.3	Track, T-slot type, 2.3 m / 90.5"	X	X	X	X	X		X	X
49032301	TS3.45	Track, T-slot type, 3.45 m / 11"	X	X	X	X	X		X	X



TRACK SYSTEM ACCESSORIES, WALL SAWING										
43101401	TF2S	Track foot, (symmetric type) for TS type tracks	X	X	X	X	X			X
43100901	TFAB	Angle cutting attachment, to be bolted to TF2S	X	X	X	X	X			X
43280101	TSS300	Joint block for TS type tracks	X	X	X	X	X		X	
55070201	TP3	Trackstop TP3 cpl	X	X	X	X	X		X	X
4385101		Drill template for positioning symmetric track foot	X	X	X	X	X			
4385301		Drill template for positioning symmetric track foot, double	X	X	X	X	X			



BASE PLATES, WHEELS AND ACCESSORIES, TRACK SYSTEM RIG													
BTS4	BTS4	Base plate for TS type tracks, rectangular, 220 x 320 mm									X	X	X
WT-BTS4	WT-BTS4	Wheel kit for BTS-4 base plate									X	X	X
BTS5	BTS5	Base plate for TS type tracks, rectangular, 380 x 290 mm For wire sawing and heavy duty drilling									X	X	X
WT-BTS5-200	WT-BTS5-200	Wheel kit, BTS-5, Ø200									X	X	X
WT-BTS5-300	WT-BTS5-300	Wheel kit, BTS-5, Ø300									X	X	X
HL-TS1	HL-TS1	Handle with levels. For Pentrunder universal drill rig										X	X
RST-TS1	RST-TS1	Rear support for TS Track									X	X	X
CEG-PDT1	CEG-PDT1	Pivoting head for TS track, pivots 360°, one feed gear									X	X	X
CEL-TS	CEL-TS	Carriage for line and corner drilling with TS type track										X	X
CT-CEL	CT-CEL	Back support for CEL-TS cpl.										X	X
													
GLIDING CARRIAGE, ELECTRIC FEED, TRACK SYSTEM RIG													
CEG-E-3P8	CEG-E-3P8	Carriage, gliding, 3P8 wire saw upper carriage, electric feed, total gear ratio 5000:1. Max feed speed 0.4 m/min									X		
CEG-E-MD1	CEG-E-MD1	Carriage, gliding. MD1 drilling carriage or lower carriage 3P8 wire saw, electric feed, total ratio 2500:1. Max feed 0.8 m/min									X	X	
													
GLIDING CARRIAGES, MANUAL FEED, TRACK SYSTEM RIG													
CEG-M25	CEG-M25	Carriage, gliding, MD1 drilling carriage or lower carriage 3P8, manual, gear ratio 25:1									X	X	X
													
ROLLER CARRIAGES, MANUAL FEED, TRACK SYSTEM RIG													
CER-M3-MD1	CER-M3-MD1	Carriage, roller type for drilling, MD1 QDC coupling, manual feed, gear ratio 3:1										X	
CER-M3-U	CER-M3-U	Carriage, roller type for drilling, Universal, manual feed, gear ratio 3:1											X
HK-1	HK-1	Hand crank for CEG and CEG carriages and MDU Core Drill										X	X
													

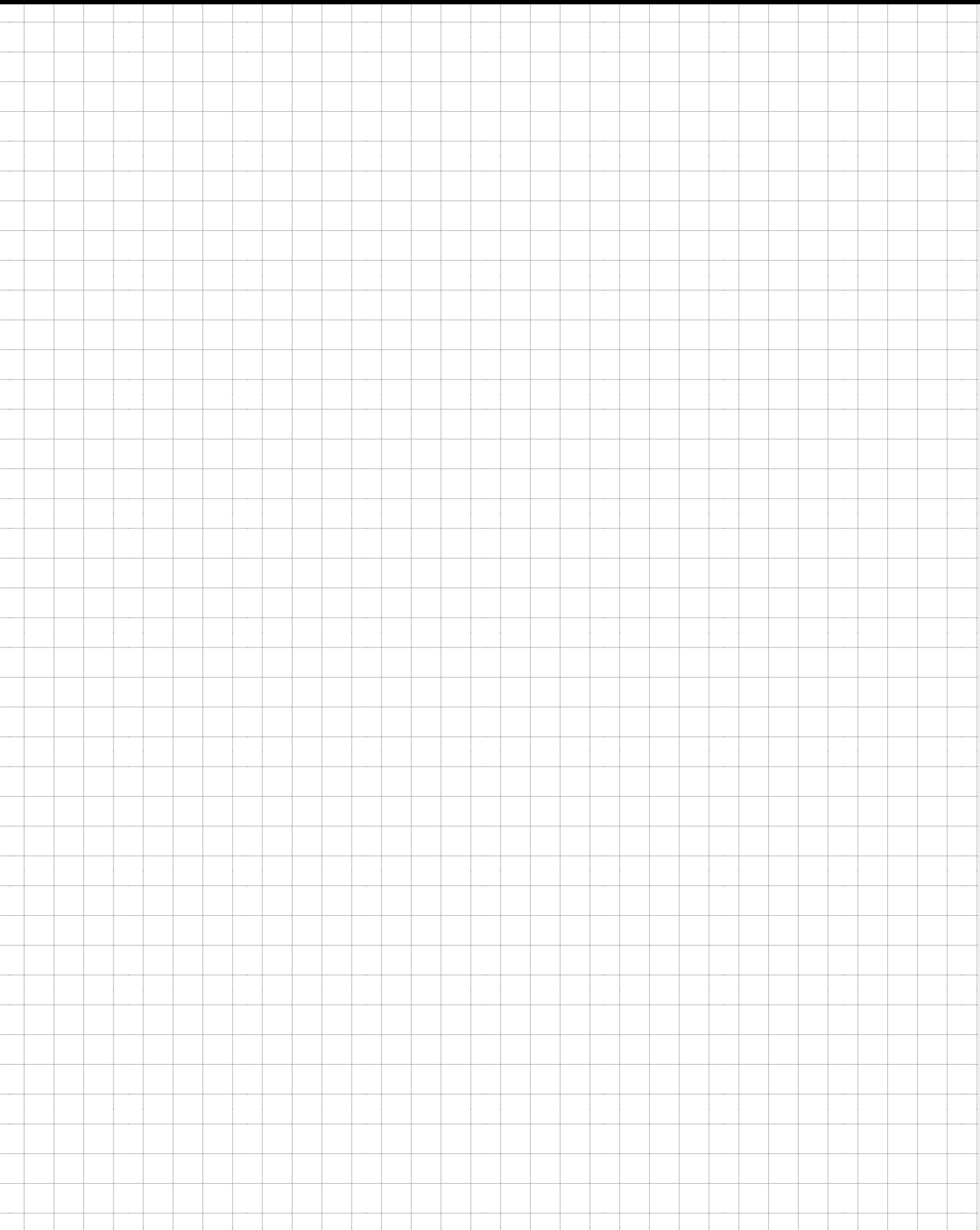



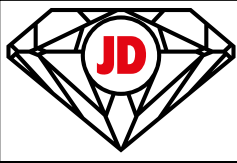

# Diamantværktøj

**Official Pentrunder Distributor:**

J.D. Diamantværktøj A/S  
Glentevej 33  
DK-4600 Køge

Tlf.: (+45) 56 65 50 40  
Fax: (+45) 56 65 61 45  
CVR-nr: 39 21 58 10  
[www.jd-diamant.dk](http://www.jd-diamant.dk)

***Pentrunder***<sup>®</sup>  
**CONCRETE CUTTING SYSTEMS**

Pentrunder - designed and manufactured by:  
Tractive AB | Gjutargatan 54 | 781 70 Borlänge | Sweden  
[www.pentrunder.com](http://www.pentrunder.com) | [contact@pentrunder.com](mailto:contact@pentrunder.com)